

# MULTI TURN 360°

## Horizontal Input

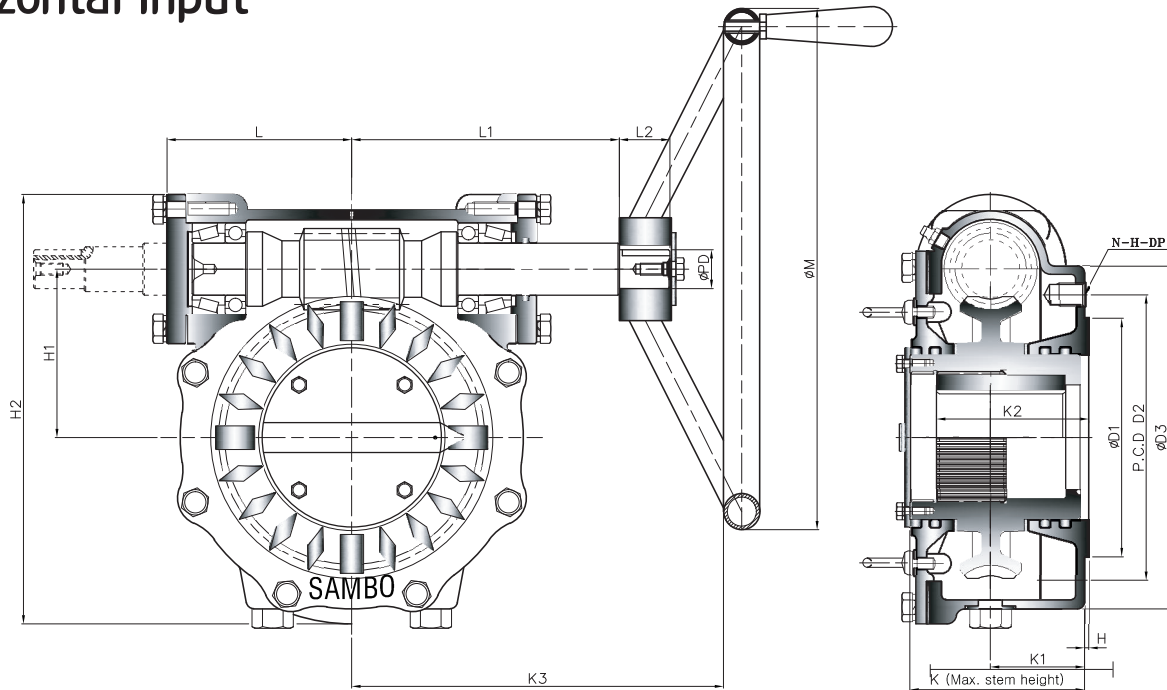

• Pin hole size is same as tap out diameter

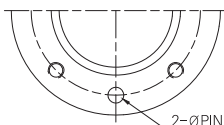

TYPE - A

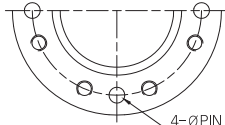

TYPE - B

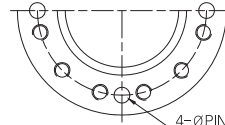

TYPE - C

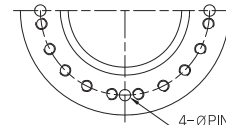

TYPE - D

### Dimension

UNIT : mm

MODEL	DIM	BASE PART						EXTERNAL PART							INPUT SHAFT PART			HAND WHEEL		
		TYPE	FLANGE	ØD1	P.C.D		ØD3	H	H1	H2	K	K1	K2	K3	L	L1	L2		ØPD	KEY
					ØD2	N-H-DP														
SBWG-BFMT	A	F-07	55	70	4-M8-12	110	2	42	132	76	38	38.6	150	64	97	24	16	6X6	200	
SBWG-0MT		F-10	70	102	4-M10-15	135		57	159.5	77	38	43.6	177	71.5	104.5				250	
SBWG-00MT		F-12	85	125	4-M12-18	165		69.5	192	86.5	43	53.6	230	86	138				300	
SBWG-01MT		F-14	100	140	4-M16-24	190		82.5	217.5	96	53	65	260	95	147				400	
SBWG-02MT		F-16	130	165	4-M20-30	220		97	257	109.5	56	75.5	294	108	166				500	
SBWG-03MT	B	(F-16) F-20	160	205	8-M16-24	250	3	112	287	116	59	87	324	118	176	34	26	8X7	560	
SBWG-35MT		F-25	200	254	8-M16-24	300		127	319.5	126	63	91	329	125	181				560	
SBWG-04MT		F-25	200	254	8-M16-24	300		153	385.5	147	73	120	370	153	207				630	
SBWG-05MT		F-30	230	298	8-M20-30	350		180	437.5	155	78	141	400	163	217				710	
SBWG-55MT						350		202	484.5	162	80	144	420	183	237					
SBWG-06MT		F-35	260	356	8-M30-45	415		230	558.5	200	109	175	489	117	286				800	
SBWG-07MT		F-40	300	406	8-M36-55	475		280.5	660.5	227	116	209	538	252	315				900	
SBWG-75MT	C	F-48	370	483	12-M36-55	560	5	326	776	246	120	220	617	279	381	58	50	16X10	1000	
SBWG-08MT						560		379	884	254	125	245	652	314	416					
SBWG-09MT	D	F-60	470	603	20-M36-55	700	5	448.5	1023.5	284	138	270	692	354	456	58	50	16X10	1000	
SBWG-10MT						800		513	1191	352	164	330	814	426	614					
SBWG-11MT						900		616.5	1399.5	400	181	370	857	468.5	657					
SBWG-12MT						1000		711	1621	484	265	455	980	554	702					
SBWG-13MT						1000		809	1814	546	301	515	988	609	752					

# Worm Gear Actuators

## Feature

- All mounting bases conform to ISO 5210/1 standards.
- All castings are ductile iron, Class 65-45-12 excellent strength and impact resistance.
- Worm gear material is available in two option.
  - ▶ Ductile iron, Class 80-55-06
  - ▶ Aluminum bronze, B148-C95800
- Worm is 1045 heat treated Carbon steel.
- Removable splined bushing to permit accurate positioning between gear drive and valve stem.
- Options include hand wheels, chain wheels and etc.

### Bushing Type

Splines permit accurate alignment of valve stem key.

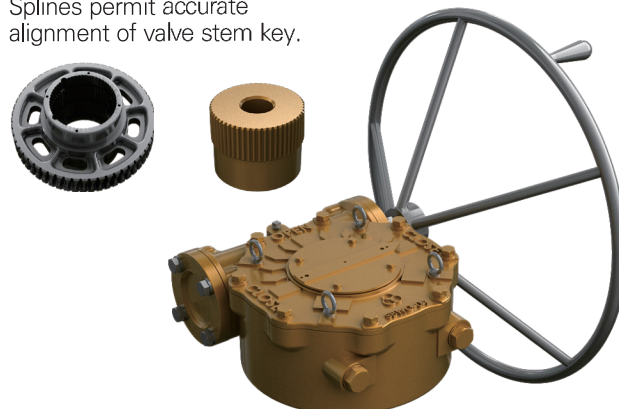

### M · O · V OPTION

Worm Gear can be provided with Motor actuator input flanges to accept standard ISO Mounting Base.

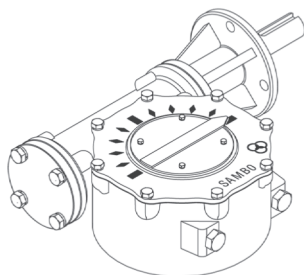

### LOCKING DEVICE OPTION

Input can be equipped with a Handwheel locking device for Manually operated units.

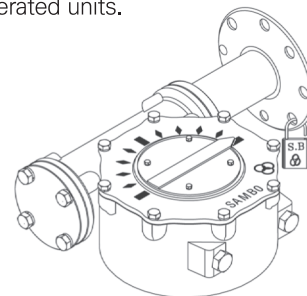

## Selection Chart for Manual Operation

MODEL \ SIZE	GEAR RATIO	MAX. STEM ACCEPTANCE	MOUNTING OPTION & STANDARD	MAX. TORQUE CAPACITY		WEIGHT
				N-m	Ft. lbf	Kg
SBWG-BFMT	32 : 1	20 (6X6)	F-07	360	266	6
SBWG-0MT	36 : 1	28 (8X7)	F-07, F-10	780	575	9
SBWG-00MT	40 : 1	36 (10X8)	F-10, F-12	1200	885	13
SBWG-01MT	44 : 1	46 (14X9)	F-10, F-12, F-14	2000	1475	16
SBWG-02MT	48 : 1	60 (18X11)	F-12, F-14, F-16	2800	2065	25
SBWG-03MT	52 : 1	75 (20X12)	F-14, F-16, (F-20)	4300	3172	34
SBWG-35MT	52 : 1	80 (22X14)	F-16, (F-20), F-25	6100	4499	39
SBWG-04MT	56 : 1	95 (25X14)	F-16, (F-20), F-25	10400	7671	63
SBWG-05MT	60 : 1	115 (32X18)	F-25, F-30	15900	11727	85
SBWG-55MT	62 : 1	125 (32X18)	F-25, F-30	23500	17333	105
SBWG-06MT	64 : 1	140 (36X20)	F-25, F-30, F-35	32800	24192	155
SBWG-07MT	68 : 1	180 (45X25)	F-30, F-35, F-40	51100	37689	254
SBWG-75MT	66 : 1	210 (50X28)	F-35, F-40, F-48	81500	60111	364
SBWG-08MT	66 : 1	250 (56X32)	F-40, F-48	121000	89245	489
SBWG-09MT	66 : 1	280 (63X32)	F-48, F-60	192500	141981	848
SBWG-10MT	64 : 1	320 (70X36)	F-60	275000	202830	1352
SBWG-11MT	68 : 1	360 (80X40)	F-60	442000	326002	2113
SBWG-12MT	70 : 1	400 (90X45)	F-60, (F-80)	610000	449913	2931
SBWG-13MT	72 : 1	440 (100X50)	F-60, (F-80)	970000	715435	3835

Size and component specification in this catalogue are subject to change without prior notice for quality improvement.